

SMD Power Inductors

SSL I 306 Series



FEATURES

High energy storage and very low resistance.

Smallest size and high performance

PRODUCT IDENTIFICATION

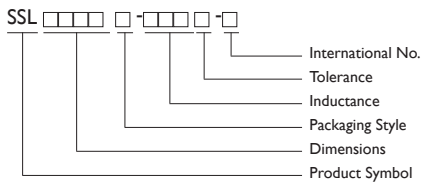

- Packaging: T : Tape and Reel
- Tolerance: M: $\pm 20\%$
- Note: YAGEO will start to release SSL Series inductors with lead-free terminals which meet SONY SS-00259's criteria for lead-free product in Q2 of 2004, and YAGEO Internal No will be changed to "N" as identification. Ex. SSL04LP-1R2M-N

SHAPES AND DIMENSIONS

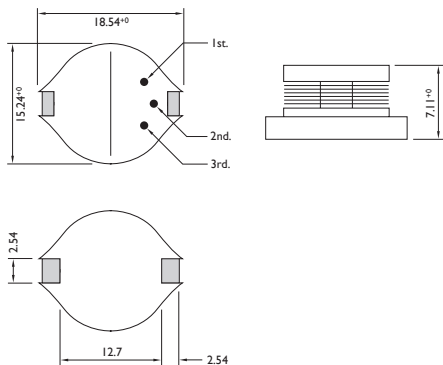

Dimensions : mm

For SSL series provide excellent current carrying capabilities in a small footprint. They have a flat top for reliable pick and place operations and features robust temperature deflection. In addition to the standard versions shown here, custom inductors are available to meet your exact requirement.

APPLICATIONS

Notebook computers, Sep-up and step-down converters

Flash, memory programmers. Etc...

ELECTRICAL CHARACTERISTICS

PART NO.	INDUCTANCE ($\mu\text{H} \pm 20\%$)*	SRF (MHz)	DC RESISTANCE (Ω^{th})	Isat** (A)	Irms*** (A)
SSLI306T-1R0M-S	1.0	80	0.011	20	8.6
SSLI306T-2R2M-S	2.2	80	0.014	16	7.1
SSLI306T-3R3M-S	3.3	60	0.016	14	6.2
SSLI306T-5R6M-S	5.6	40	0.022	12	5.3
SSLI306T-100M-S	10	30	0.032	10	4.3
SSLI306T-150M-S	15	22	0.036	8.0	4.0
SSLI306T-220M-S	22	20	0.047	7.0	3.5
SSLI306T-330M-S	33	15	0.066	5.5	3.0
SSLI306T-470M-S	47	9	0.087	4.5	2.6
SSLI306T-680M-S	68	8	0.13	3.5	2.3
SSLI306T-101M-S	100	7	0.19	3.0	1.8
SSLI306T-151M-S	150	6	0.25	2.6	1.5
SSLI306T-221M-S	220	5	0.38	2.4	1.2
SSLI306T-331M-S	330	4	0.56	1.9	1.0
SSLI306T-471M-S	470	3	0.85	1.4	0.82
SSLI306T-681M-S	680	2.5	1.2	1.2	0.72
SSLI306T-102M-S	1000	2	1.8	1.0	0.56

* Inductance Tested at 0.1 Vrms, 100 KHz

** Inductance Drop = 10% Typ. at Isat.

*** $\Delta T = 40^\circ\text{C}$ Rise Typ at I rms.

Operating Temperature Range -40°C to $+85^\circ\text{C}$



ELECTRICAL CHARACTERISTICS : LEAD-FREE & ROHS COMPLIANCE

PART NO.	INDUCTANCE (nH)	TEST FREQUENCY (MHZ)	R _{dc} (Ω)	I _{sat} (A)	I _{rms} (A)	SRF (KHz)Typ.
SSLI306T-1R0 □ -N	1	100KHz,0.1V	0.011+15%	20	8.6	80
SSLI306T-2R2 □ -N	2.2	100KHz,0.1V	0.014+15%	16	7.1	80
SSLI306T-3R3 □ -N	3.3	100KHz,0.1V	0.016+15%	14	6.2	60
SSLI306T-5R6 □ -N	5.6	100KHz,0.1V	0.022+15%	12	5.3	40
SSLI306T-100 □ -N	10	100KHz,0.1V	0.032+15%	10	4.3	30
SSLI306T-150 □ -N	15	100KHz,0.1V	0.036+15%	8	4	22
SSLI306T-220 □ -N	22	100KHz,0.1V	0.047+15%	7	3.5	20
SSLI306T-330 □ -N	33	100KHz,0.1V	0.066+15%	5.5	3	15
SSLI306T-470 □ -N	47	100KHz,0.1V	0.087+15%	4.5	2.6	9
SSLI306T-680 □ -N	68	100KHz,0.1V	0.13+15%	3.5	2.3	8
SSLI306T-101 □ -N	100	100KHz,0.1V	0.19+15%	3	1.8	7
SSLI306T-151 □ -N	150	100KHz,0.1V	0.25+15%	2.6	1.5	6
SSLI306T-221 □ -N	220	100KHz,0.1V	0.38+15%	2.4	1.2	5
SSLI306T-331 □ -N	330	100KHz,0.1V	0.56+15%	1.9	1	4
SSLI306T-471 □ -N	470	100KHz,0.1V	0.85+15%	1.4	0.82	3
SSLI306T-681 □ -N	680	100KHz,0.1V	1.2+15%	1.2	0.72	2.5
SSLI306T-102 □ -N	1000	100KHz,0.1V	1.8+15%	1	0.56	2

NOTE : □ -tolerance M=±20%

1.Operating temperature range -40°C~85°C

2.Inductance drop 20% typ. at last

4. ΔT=40°C rise typ.at I_{rms}.

"-N"FOR COMPLETELY LEAD FREETYPE(INCLUDING FERRITE BODY & SOLDER)



TAPE DIMENSIONS

Dimensions : mm

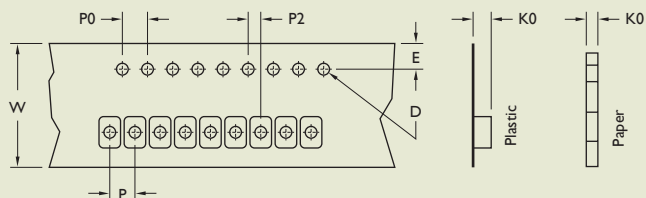

TYPE	TAPE DIMENSIONS						
	K0	D	E	W	P	P0	P2
SSL0402	3.2	1.55	1.75	12	8	4	2
SSL0802	3.75	1.55	1.75	24	16	4	2
SSL0804	5.4	1.55	1.75	24	16	4	2
SSL0810	11.5	1.55	1.75	24	20	4	2
SSL1306	7.5	1.55	1.75	32	20	4	2

REEL DIMENSIONS

Dimensions : mm

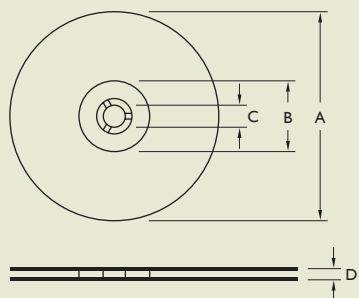

TYPE	REEL DIMENSIONS				QUANTITY /REEL	
	A	B	C	D	178	330
SSL0402	330	100	13	13.4	-	2500
	178	60		13.2	750	-
SSL0802	330	100	13	24.4	-	1000
SSL0804	330	100	13	24.4	-	750
SSL0810	330	100	13	24.4	-	225
SSL1306	330	100	13	33.4	-	250

RECOMMENDED PATTERN

Dimensions : mm

Land Pattern

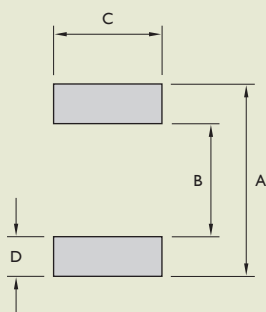

RECOMMENDED PATTERN

	A	B	C	D
SSL0402	6.86	4.06	3.58	1.40
SSL0802	13.21	7.37	2.79	2.92
SSL0804	13.21	7.37	2.79	2.92
SSL0810	13.21	7.37	2.79	2.92
SSL1306	18.29	12.45	2.79	2.92

TAPE MATERIAL

Carrier Tape : Polystyrene

Cover Type : Polyethylene

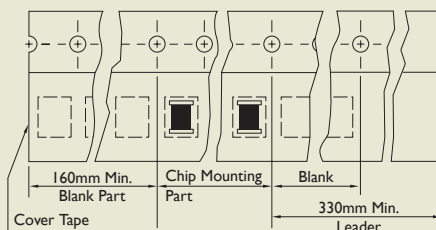



SSL SERIES RELIABILITY TEST

I-1 MECHANICAL PERFORMANCE

NO.	ITEM	SPECIFICATION	TEST CONDITIONS
I-1-1	Vibration	Appearance : No Damage L Change : within $\pm 10\%$ Q Change : within $\pm 30\%$ RDC : within Specification	Test device shall be soldered on the substrate. Oscillation Frequency : 10 to 55 to 10Hz for 1Min. Amplitude : 1.5mm Time : 2Hrs. for each Axis (X,Y & Z), Total 6Hrs.
I-1-2	Resistance to Soldering Heat	Appearance : No Damage	Pre-heating : 150°C, 1Min. Solder Composition : Sn/Pb = 63/37 Solder Temperature : 260 \pm 5°C Immersion Time : 10 \pm 1Sec.
I-1-3	Solderability	The electrodes shall be at least 90% covered with new solder coating.	Pre-heating : 150°C, 1Min. Solder Composition : Sn/Pb = 63/37 Solder Temperature : 230 \pm 5°C Immersion Time : 4 \pm 1Sec.

I-2 ENVIRONMENTAL PERFORMANCE

NO.	ITEM	SPECIFICATION	TEST CONDITIONS															
I-2-1	Temperature Shock	Appearance : No Damage L Change : within $\pm 10\%$ L Change : within $\pm 30\%$ RDC : within Specification	10 Cycles (Air to Air) Cycles shall Consist of : 30Min. Exposure to -55°C 30Min. Exposure to 125 \pm C 15Sec. Max. Transition between Temperatures Measured after Exposure in the Room Condition for 24Hrs.															
I-2-2	Temperature Cycle		One Cycle <table border="1"> <thead> <tr> <th>Step</th> <th>Temperature (°C)</th> <th>Time (Min.)</th> </tr> </thead> <tbody> <tr> <td>1</td> <td>-25 \pm 3</td> <td>30</td> </tr> <tr> <td>2</td> <td>25 \pm 2</td> <td>3</td> </tr> <tr> <td>3</td> <td>85 \pm 3</td> <td>30</td> </tr> <tr> <td>4</td> <td>25 \pm 2</td> <td>3</td> </tr> </tbody> </table> Total : 100 Cycles Measured after Exposure in the Room Condition for 24Hrs.	Step	Temperature (°C)	Time (Min.)	1	-25 \pm 3	30	2	25 \pm 2	3	3	85 \pm 3	30	4	25 \pm 2	3
Step	Temperature (°C)	Time (Min.)																
1	-25 \pm 3	30																
2	25 \pm 2	3																
3	85 \pm 3	30																
4	25 \pm 2	3																
I-2-3	Humidity Resistance		Temperature : 40 \pm 2°C Relative Humidity : 90 ~ 95% Time : 1000Hrs. Measured after Exposure in the Room Condition for 24Hrs.															
I-2-4	High Temperature Resistance		Temperature : 85 \pm 3°C Relative Humidity : 20% Applied Current : Rated Current Time : 1000Hrs. Measured after Exposure in the Room Condition for 24Hrs.															
I-2-5	Low Temperature Resistance		Temperature : -25 \pm 3°C Relative Humidity : 0% Time : 1000Hrs. Measured after Exposure in the Room Condition for 24Hrs.															



TYPICAL ELECTRICAL CHARACTERISTICS

Curves of SSL Series

Test Instruments :

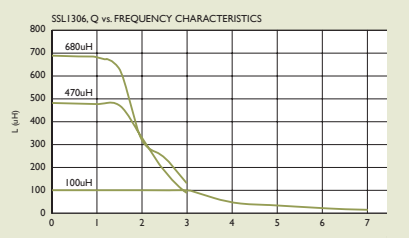
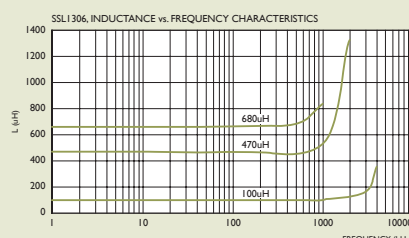
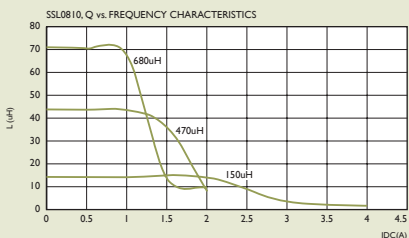
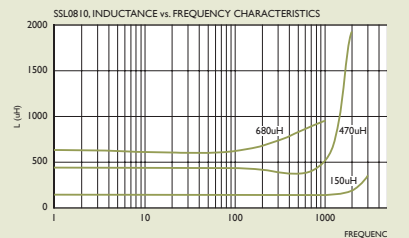
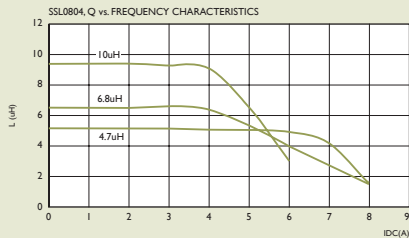
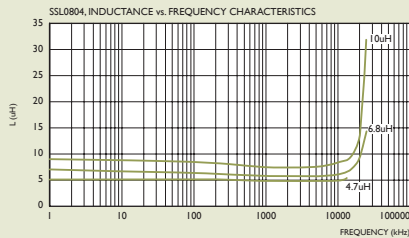
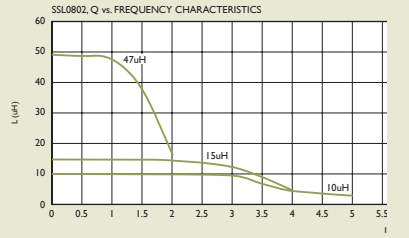
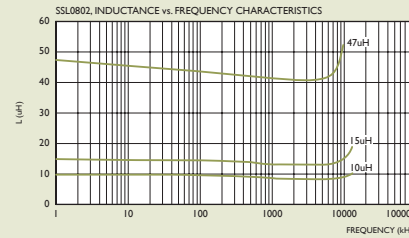
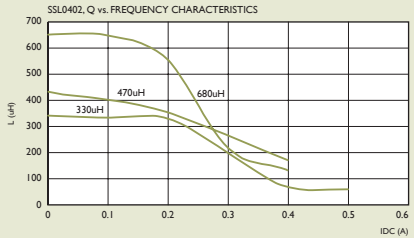
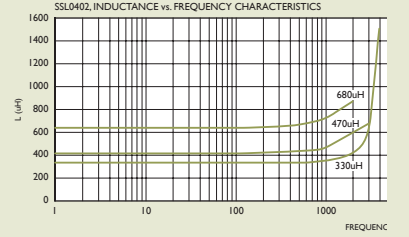
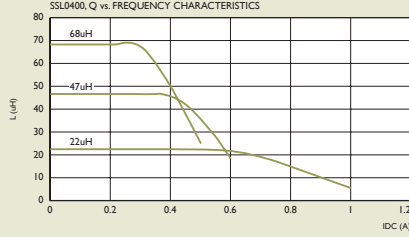
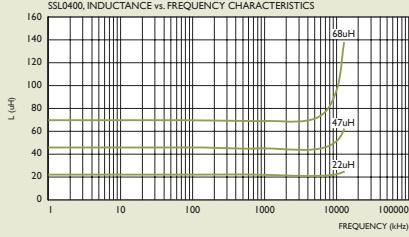



RECOMMEND SOLDERING CONDITIONS

for: CL/ CLH/ SQV/ SMD power inductors/ SMD Chip Beads/ SMD Filters, Transformers, Current Sensors

